



INTERNATIONAL APPLICATION PUBLISHED UNDER THE PATENT COOPERATION TREATY (PCT)

Form with fields for (31) International Patent Classification, (32) International Publication Number, (33) International Publication Date, (34) Agent, (35) Designated States, (36) Priority data, (37) Applicants, (38) Inventors, and (39) Title: MEDICAMENT DISPENSING DEVICE

(37) Abstract

A medicament dispensing device comprising an inhalation nozzle (50), a reservoir (10) for containing a supply of medicament in powder form, a dispensing slide (46) for receiving a dose of powder from the reservoir and for passing the dose for inhalation through the nozzle (50), and a movable cover (13) for the nozzle, a dose of powder being first loaded into a cavity (77) in the slide (46) with the slide (46) then being moved to present a dose of medicament for inhalation, in response to opening of the cover.

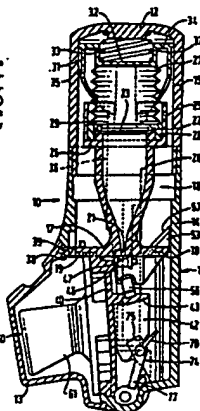

Table titled 'FOR THE PURPOSES OF INFORMATION ONLY' listing countries and their corresponding PCT codes.

WO 94/05359

PCT/GB93/01893

MEDICAMENT DISPENSING DEVICE

This invention relates to a dispensing device, and more specifically, to a device suitable for dispensing discrete amounts of a particulate material entrained in an air flow. In particular, the invention is concerned with a dispensing device of the type where a metered dose is administered on inhalation by a patient.

Metered dose inhalers are well known in medicine for treatment, or alleviation of the effects of respiratory complaints, for example asthma. Many of these devices are for use with a pressurized aerosol dispensing container. However, inhalers for dispensing metered doses of drugs in dry powder form are also known.

US-2,587,215 describes devices having separate drug reservoirs and air mixing chambers in which metered doses of the drug are dispersed in an air stream which is inhaled by a patient. The metering member is in the form of either a slide plate having a metering hole therein for receiving a drug dose, or a rotatable slide member having dose-receiving depressions in its upper surface. EP-0,488,609 similarly describes a slide plate dose metering device.

EP-0,069,715 describes a device in which doses of drugs are transferred by a perforated membrane from a storage reservoir across an air conduit through which air inhaled by a patient is drawn.

EP-0,079,478; EP-0,166,294 and GB-2,165,159 describe devices in which a drug dose is transferred from a storage reservoir to a passage for air inhaled by a patient located immediately beneath the reservoir, in a recess formed in a rotatable metering member positioned between the reservoir and the air passage.

US-4,274,403 describes an inhaler having a rotary metering member with a drug dose receiving aperture therethrough. The metering member is slidable between

WO 94/05359

PCT/GB93/01893

positions in which the aperture is aligned with an outlet of a drug storage reservoir for loading a dose of drug into the aperture, and in which it is aligned with an inhalation nozzle. The metering member also has a further passage communicating with the drug receiving aperture therein, the passage being open to the ambient atmosphere when the aperture is aligned with the inhalation nozzle to allow air to be drawn through the aperture and to entrain the drug therein for inhalation by a patient.

WO 92/00771 describes an inhaler having a rotary metering member with drug dose-receiving depressions in its periphery. A dose of drug is loaded in each depression when aligned with a drug storage reservoir. The metering member is rotated to bring a dose laden depression into communication with an air inhalation passage for inhalation of the drug dose by a patient.

WO 92/10229, in our name, describes an inhaler which utilizes a flow of compressed air to fluidize and load powdered medicament contained in a storage reservoir, into a dose metering chamber for inhalation by a patient. A controlled air bleed through the metering chamber is achieved to provide a full dose of drug in the metering chamber.

WO 92/09322 describes an inhaler having a rotatable metering drum for receiving powder doses and for delivering such doses to an inhalation mouthpiece. The device has an air channel communicating with a metered dose in the metering drum for discharging the dose in an air flow inhaler through the mouthpiece.

WO 90/13327 describes a dry powder inhaler where discrete doses of the powder are carried on tape. The doses are removed from the tape into an inhaled air stream by deagglomeration/aerosolisation means which are cocked by opening a protective cover and are actuated on inhalation by a patient.

WO 92/04928 describes a powder inhaler having a spring loaded cylindrical dosing plunger which is loaded with a dose of powder stored in a reservoir. When a cap of the inhaler is

removed, the dosing plunger is moved by its spring loading to bring the dose into communication with a whirl mixing chamber through which inhaled air passes.

However a powder dose is loaded into and remains in the dose receiving recess in the plunger from the time the cover is replaced until the next use of the inhaler. Since powder blends are generally hygroscopic, any moisture in the dose receiving recess tends to make the powder dose adhere to the surfaces of the recess. This tends to prevent a full dose from being delivered during the next inhalation. This is aggravated if the patient exhales into the device thereby coating the plunger recess with moisture. Since a dose of powder is reloaded into the recess immediately it is depressed into the powder reservoir on replacing the cover, there is no opportunity to use a desiccant to absorb any moisture in the dose receiving recess before it receives a powder dose.

Another disadvantage of this device is that the cover is not retained on the inhaler. If the cover is lost the inhaler becomes inoperative which could have severe consequences for a patient relying on use of the inhaler.

A further disadvantage is that the powder is loaded by a spring biased plate acting on the powder in the reservoir. This force tends to result in the powder being compacted to different degrees at different parts of the reservoir which can adversely affect the loading thereof into the recess in the plunger.

The object of the invention is to provide improvements in dry powder medicament dispensing devices to facilitate the operation thereof. It is also an object to improve the delivery of drug doses so as to achieve more consistency in the metered doses of the drug.

The invention provides a medicament dispensing device comprising an inhalation nozzle, a reservoir for containing a supply of medicament in powder form, metering means for producing a dose of powder from said reservoir, dispensing means for presenting such dose for inhalation through said nozzle, a movable cover for said nozzle, and actuating means,

Figure 1 is a vertical section through a dry powder inhaler embodying the invention;

Figure 2 is an exploded view, on a reduced scale, of the inhaler of Figure 1;

Figures 3A and 3B to Figures 8A and 8B are, respectively, side and sectional views of the inhaler illustrating an opening and closing sequence of the mouthpiece cover and the corresponding positions of the dose delivery slide;

Figures 9A and 9B are diagrammatic sectional details of the hopper and mouthpiece assembly of the inhaler illustrating the air flows therethrough;

Figures 10A and 10B are, respectively, a sectional side view and an end view of the mouthpiece assembly;

Figures 11A and 11B are diagrammatic illustrations of cans provided on the mouthpiece cover showing their cooperation with yoke arms for controlling actuation and resetting of the dose delivery system;

Figure 12 is a diagrammatic representation of a resilient can track portion provided on a yoke assembly of the inhaler;

Figures 13A-13D are respective diagrammatic illustrations of an alternative triggering mechanism shown in different pivotal positions of the mouthpiece cover; and

Figure 14 is a vertical cross-section through an alternative dose slide carrier assembly.

Referring to the drawings, the inhaler (10) comprises a hollow substantially cylindrical body (11) which is closed at its upper end by a cap portion (12) and has a hinged mouthpiece cover (13) which normally closes an aperture in a lower portion of the side wall of the cylindrical body (11). The body (11) comprises a lower case portion (14) on which the mouthpiece cover (13) is hingedly mounted to be captively retained thereon, and an upper case closed portion (15). The upper and lower case portions (14 and 15) of the body (11) have overlapping, interengageable portions which are provided with cooperating screw threads or other joining means, e.g. a snap connection, for facilitating assembly of the inhaler (10).

responsive to movement of the cover, for causing actuation of said dispensing means, characterized in that said actuating means include means, responsive to movement of the cover, for causing actuation of said metering means, and, in that, said actuating means are adapted to cause actuation of said metering means and subsequent actuation of said dispensing means, in response to movement of the cover.

An advantage of a device according to the invention over WO 92/04928 is that during storage the metering recess is empty thus minimising the risk of dose adhering to the cup due to hygroscopic action of the drug compound.

According to a feature of the invention, the cover may remain fixed to the device e.g. by hinging means. An advantage of this feature is that it is then not possible to lose the cover, which would render the device inoperative and thus the patient would be without medication.

According to a further feature of the invention, the metering means may be pneumatic. This feature has the advantage that air flow through the porous powder moves the entire bulk reservoir and applies a metering force at the dose cup with little compaction of the bulk. The result is very consistent powder density in the metering cup - leading to a consistent metered dose. In system of WO 92/04928 the spring force acting on the top of the blend in the bulk reservoir provides the metering force remote from the dosing recess. This means that the metering force is dependent on the powder characteristics and depth of powder so that it is unlikely that the dosing will be consistent. It is well known that powder is compressible, typically up to 30% for pharmaceutical powders, and so applying force to the powder bulk will result in varying powder density and thus varying dose size. It is undesirable in a drug delivery system that the delivered dose should increase substantially over the life of the system.

An embodiment of the invention will now be described by way of example and with reference to the accompanying drawings, in which:-

A hopper unit (16), for containing a supply of a drug in powdered form, is located within the body part (11). The hopper unit (16) has a generally planar base portion (17) provided with a downwardly notched outer periphery at (18) for engagement with an arcuate ledge portion (19) formed around a portion of the inner wall of the lower case part (14). The hopper unit is disposed in the lower case (14) with the upper case (15) separated therefrom. The hopper unit (16) is formed with a reservoir (20) for containing a supply of the powdered drug. The reservoir (20) has an annular wall which converges progressively towards its lower end at which a discharge orifice (21) is defined. The reservoir (20) is formed integrally with the base section (17). The upper end of the wall of the reservoir (20) is formed with an internal notch (22) for seating a circular disc (23) which is air permeable. The upper end of the annular wall of the reservoir (20) is also provided with an encircling cylindrical wall (25) integrally joined to the wall of the reservoir (20) by an annular portion (26).

A bellows (27) comprises a corrugated wall having a closed upper end and having at its lower end an integral sealing ring (28). The sealing ring has an outer annular portion which locates in an annular channel defined between the upper end of the wall of the reservoir (20) and the encircling cylindrical wall (25). The yoke member (31) has an inwardly directed flange portion (29) which is downturned at its inner edge for engaging around the upper end of the wall of the reservoir (20) to locate in the notch (22) in contact with the disc (23) located therein.

To complete the upper assembly of the powder dispensing apparatus, a yoke member (31) is located on and in contact with the top of the bellows (27). The yoke member (31) has an upper portion comprising a disc-like base portion (32) with an integral upstanding cylindrical wall portion (33) which, at its upper end, extends radially outwardly to provide an annular portion (34) and then axially downwardly to provide an encircling cylindrical wall (35) which has an internal

diameter greater than the external diameter of the cylindrical wall (25) of the hopper unit (16). A compression spring (37) is engaged within the cylindrical central recess defined by the base (32) and upstanding wall (33) of the yoke member and is held in compression when the top case part (15) is fully screw threadably engaged with the lower case portion (14). In order to maintain the compression spring in its compressed state while the mouthpiece cover (13) is in its closed position, thereby preventing dispensing of a dose of powdered medicament from the reservoir (20), the yoke member (31) has a pair of downwardly depending elongate limbs (36), the lower ends of which cooperate with cam portions (70,71) formed integrally with the cover (13) as described below.

The hopper unit (16) has a leg portion (40) downwardly depending from the base part (17) at an acute angle with respect thereto. A circular recess (41) is formed in one side of the leg portion (40) in order to receive a mounting section of a mouthpiece and cyclone assembly described below. The hopper unit (16) also includes an integral mounting section comprising a side wall (42) extending generally perpendicular to the leg portion (40) and having a transverse ledge (43) for mounting a movable dose dispensing slide assembly (44) which is described below.

The hopper assembly (16) is also formed with a channel (45) open at either end for the passage of air therethrough. The channel (45) is also downwardly open along the underside of the base plate portion (17) of the hopper unit.

The dose dispensing slide unit (44) comprises a slide member (46) having a dose receiving depression (47) formed in an upper surface thereof and a vent aperture (47a) therethrough. The slide plate is maintained in contact with the underside of the base plate (17) of the hopper unit for sliding movement between a first position in which the dose receiving depression (47) is located beneath the outlet orifice (21) of the drug reservoir (20) and a second position in which the depression (47) containing the dose of drug is placed in a primary air mixing chamber provided by the channel

(45) in the hopper unit base plate (17). In the first position, the vent aperture (47a) communicates with the channel (45). The slide (46) is in the form of a narrow plate with the depression (47) formed in its upper surface. At one end of the slide, a pair of spaced transverse walls (48,49) project upwardly and are received in a slot in the hopper base plate (17). The slide (46) also has a laterally projecting peg (50). The slide (46) is spring biased to its second position in which its depression (47) is placed in the primary mixing chamber (45). For this purpose, a leaf spring (51) is provided, one end of the spring being located in the slot defined between the walls (48,49) of the slide and the other end of the leaf spring being fixed to an outer side wall portion of the reservoir (20).

The slide member (46) is mounted on a slide carrier (53) which has in its upper surface a channel (54) in which the slide member (46) is slidably mounted and in its lower surface a recess (55) for receiving a biasing spring (56). The slide mounting (53) has an upwardly projecting narrow flange (57) which defines with a lower portion of the side wall of the reservoir (20) an inlet air passage to the primary mixing chamber (45).

The spring (56) which extends at an angle to the vertical axis of the device, biases the slide member (46) when located in the upper channel (54) of the slide mounting (53), against the underside of the hopper base plate (17) and also into contact with the side wall of the leg portion (40) of the hopper unit. The contact between the slide member (46) and the base plate (17) and leg portion (40) of the hopper unit is such that pressurized air can bleed therebetween without permitting the passage of the powdered drug therebetween. This is a feature of the method of loading a dose of drug into the metering depression (47) in the slide plate, which is described below.

A further element of the device is an integral mouthpiece and cyclone unit (60). The mouthpiece section (61) communicates with a secondary air and powder mixing chamber

(62). Referring to Figs. 10A and 10B, the mixing chamber (62) comprises a cyclone having four equi-angularly spaced tangential air inlets (63) arranged in an annulus around the mixing chamber. The uppermost tangential inlet passage (63) communicates with the primary mixing chamber (45) whilst the remaining three tangential inlets allow air to be drawn therethrough into the cyclone on inhalation through the mouthpiece (61). The section of the secondary mixing chamber (62) within the annulus of air inlets (63) communicates with a progressively narrowing joining portion (64) which communicates with the mouthpiece (61). The end of the mouthpiece unit (60) remote from the mouthpiece (61) is provided with a plug-like outer periphery for engaging within the recess (41) formed in the depending leg section of the hopper unit (16).

The mouthpiece cover (13) is hingedly mounted to the bottom wall of the lower case part (14) and has a resilient latching projection (38) for latching with a catch projection (39) on the lower casing (14) to hold the cover in its closed position. Opposite sides of the mouthpiece at its hinged parts, are formed with respective cam formations (70 and 71). At one side of the cover, a circular can (70) is formed in association with the cover hinge (72) for cooperation with the lower end of one of the downwardly extending limbs (36) of the yoke member (31). The can (70) has a small depression (73) at its crest portion in which the lower end of the corresponding yoke limb (36) engages when the cover is in its closed position. As the cover opens, the can moves to a position to allow the yoke to drop in order to cause actuation of the drug dispensing mechanism as described below.

At the opposite side of the cover, the can (71) cooperates with a resilient pivotally mounted trigger mechanism (74) which cooperates with the other limb (36) of the yoke member (31). The trigger (74), which is pivotally mounted on the lower casing part (14) comprises three radially extending portions, a first relatively thick portion (75) against which the end of the corresponding yoke limb (36)

locates, a second narrower portion (77) for engaging with the can (71) and a third narrower and more flexible portion (78) which resiliently abuts against the side wall of the lower case part (14) for resetting the trigger. In the closed position of the cover, the yoke is maintained in its upper position by engagement with the first trigger projection (75), the trigger being maintained in this position by engagement of the second trigger portion (77) with an abutment surface (78) on the can (71). As the cover is opened, the can (71) is rotated anti-clockwise until a second abutment surface (79) thereof engages the trigger portion (77) sufficiently to release the trigger portion (75), with a snap action, from its engagement supporting the yoke limb (36) which is thereby allowed to drop under the action of biasing spring (37) acting on the yoke. The third trigger portion (78) is then resiliently deformed against the side wall of the lower case so that when the cover is closed again and the yoke is lifted to its upper position by rotation of the can (70), the trigger is resiliently reset to its original position in engagement with the lower end of the corresponding yoke limb (36).

In order to control the action of the slide (46), one of the yoke limbs (36) is formed with a laterally projecting, resiliently mounted cam portion (80) having a three dimensional, generally triangular cam track (81) provided thereon (Figure 12). The peg (50) formed on the side of the slide member (46) engages in the cam track (81). The slide (46) is held in its initial position against the action of biasing spring (51), when the yoke member is in its upper position with the mouthpiece cover (13) in its closed position (Figs. 3A and 3B). The peg (50) is then located at the lower end of the vertical portion of the cam track (81) and remains in such position during an initial opening of the cover (13) (Figs. 4A and 4B). When the mouthpiece cover (13) is opened sufficiently to allow the yoke to move downwardly under the action of spring (36), the can moves downwardly with respect to the peg (50) until peg (50) moves to the upper end of the vertical portion (81A) of the cam track (81) (Figs. 5A and 5B).

allowing, on further opening of the cover (13), the spring (51) to move the slide (46) laterally to its second position during which the peg (50) moves along the horizontal top portion (81B) of the cam track (81) (Figs. 6A and 6B). After a drug dispensing operation and when the cover (13) is again moved towards its closed position so that the yoke is lifted, the cam then moves upwardly in relation to the peg (50) so that the peg (50) then moves along the slanted portion (81C) of the cam track (81) to bring the slide (46) back towards its initial position against the action of its biasing spring (51) (Figs. 7A and 7B).

The lower part of the slanted portion of the cam track (81) is formed with a ramp surface which terminates in an end wall (81D) which provides a side wall portion of the vertical cam track portion (81A). As the cover is further closed (Figs. 8A and 8B), the peg (50) of the slide member (46) rides over the ramp surface, which is permitted by a resilient deformation of the cam portion (80) with respect to the yoke arm (36). When the peg (50) is positioned again in the vertical cam track portion (81A), the cam portion (80) resiliently snaps back so that the end wall (81D) of the ramp then abuts the peg (50) preventing it from re-entering the slanted cam track portion.

The operation of the device is generally as follows. When the cover (13) is open sufficiently to release the trigger (74), the yoke (31) is moved downwardly under the action of its biasing spring (36). This causes the bellows (27) to be compressed which results in air being forced through the supply of powdered drug (90) located in the reservoir (20). The air flow fluidizes the powdered drug and entrains the drug so as to fill the metering depression (47) in the slide (46). As described above, this filling operation is effected by providing an air bleed between the slide (46) and the engaging portions of the hopper unit (16) to maintain an air flow through the dose receiving depression (47) thereby effectively filling that depression with powdered drug.

After a predetermined time interval during which filling of the depression (47) with a dose of powdered drug has been completed and the yoke (31) has moved down sufficiently for the slide peg (50) to have reached the upper horizontal portion (81B) of the cam track (81), the slide is moved to its second position under the action of spring (51) whereby the dose laden depression (47) is brought into the primary mixing chamber (45). The design is such that access to the mouthpiece (61) is prevented until the slide has been moved so as to bring a dose of powdered drug into the primary mixing chamber. On inhalation at the mouthpiece (61), air is drawn through the primary mixing chamber (45) causing turbulence around the drug laden depression (47) in the slide (46) which draws the dose of drug into the air stream in the primary mixing chamber (45). Continued inhalation draws the air and powdered drug mixture through the upper tangential air inlet (63) into the second cyclone mixing chamber (62) as well as drawing further swirling air flows through the other three tangential air inlets (63) of the cyclone. The thoroughly mixed air and powdered drug is then inhaled by the patient.

After use, the mouthpiece cover (13) is closed thereby lifting the yoke (35) and causing the slide (46) to be moved back to its initial position as the peg (50) thereof is moved along the slanted portion (81C) of the cam track of cam (81) as described above. The device is then ready for another drug dispensing operation.

Suitable drugs or drug blends which may be used in an inhaler described above may include salbutamol, beclomethasone dipropionate, budesonide and sodium cromoglycate.

In other embodiments, the inhaler of Figs. 1-12 could be modified so that the cyclone of unit (60) lies in a horizontal plane rather than the generally upright plane adopted in the first embodiment. Moreover, a pivotal plate valve may be provided in the exit of the nozzle (61) or in air inlets into the body (11), which communicates with the nozzle (61), to inhibit the passage of air exhaled by a patient, into the inhaler.

In a further embodiment, a modified trigger mechanism, as illustrated in Figs. 13A-13D, may be utilized. Such a mechanism, as described below, is preferably provided on each side of the cover (13) to cooperate with the respective limbs (36) of the yoke member (31). The limbs (36) are then of an equal length and the trigger (74) is omitted. This provides a more evenly balanced and more reliable triggering of the yoke member (31).

Referring to Figs. 13A-13D, each side of the cover (13) has a circular cam (100) integral therewith. The cam is formed with an arcuate triggering slot (101) therein. A modified trigger is in the form of a rotary disc (102) mounted on the inhaler body (11) in a face to face sliding disposition with the cam (100). The disc (102) has a sector shaped recess (103) formed therein. The disc (102) has an integral lateral peg (104) which engages in the triggering slot (101) of the cam (100). The lower end of the respective yoke limb (36) rests on the outer circumference of the disc (102) when the cover (13) is closed, as seen in Fig. 13A, and on the outer circumference of the cam (100) after a triggering operation, as seen in Fig. 13D.

As the cover (13) is opened, the slot (101) and the peg (104) move relative to one another, as seen in Fig. 13B, until the peg (104) engages one end of the slot (101), as seen in Fig. 13C. Further opening of the cover (13) results in the rotation of the disc (102), as seen in Fig. 13D, whereby the yoke limb (36) engages in the recess (103) in the disc causing triggering of a drug dose delivery for inhalation at the nozzle (61), as described above in relation to the first embodiment.

The disc (102) is spring biased to its rotary position as shown in Fig. 13A. Therefore, during resetting of the device on closing of the cover (13), the yoke limb (36) is lifted by the cam (100) until it is above the disc (102). The disc (102) is then moved by its spring bias to its original cocked position as shown in Fig. 13A.

Alternatively the disc (102) is reset to its original position when the lateral peg (104) engages with the opposite end of the triggering slot (101) as the cover (13) approaches its closed position.

Figure 14 illustrates another possible slide carrier assembly (120) which can replace slide carrier assembly (44) of the first embodiment.

The assembly (120) comprises a slide carrier (121) having a channel-shaped recess (122) for receiving a dosing slide (123) formed with a dose-receiving depression (124) in its upper surface. The recess (122) has a trough (125) formed in its base wall to receive a generally V-shaped spring (126). The free ends of the limbs of the spring (126) act against the underside of the slide (123) to urge it against the underside of the base plate (17) of the hopper unit.

## CLAIMS

1. A medicament dispensing device comprising an inhalation nozzle (61), a reservoir (20) for containing a supply of medicament in powder form, metering means (27,37,47) for producing a dose of powder from said reservoir, dispensing means (50,51,80) for presenting such dose for inhalation through said nozzle, a movable cover (13) for said nozzle, and actuating means (31,72,74), responsive to movement of the cover (13), for causing actuation of said dispensing means, characterized in that said actuating means include means (32-36,72,74), responsive to movement of the cover (13), for causing actuation of said metering means (27,37,47), and, in that, said actuating means (31-36,72,74) are adapted to cause actuation of said metering means (27,37,47) and subsequent actuation of said dispensing means (50,51,80), in response to movement of the cover (13).

2. A device according to Claim 1, wherein said metering and dispensing means (27,37,47;50,51,80) are actuated by opening of said cover (13) by a predetermined amount.

3. A device according to Claim 1 wherein said metering and dispensing means (27,37,47;50,51,80) are actuated by opening of said cover (13) by an amount insufficient to permit inhalation through the nozzle (61).

4. A device according to Claim 1 including an outer casing (11) for housing said reservoir (20) and said metering and dispensing means (27,37,47;50,51,80) wherein the cover (13) is movably connected to said outer casing (11).

5. A device according to Claim 4 wherein said movable cover (13) is held captive on said outer casing (11).

6. A device according to Claim 1 wherein said metering means comprises an element (46) which has means (47) for

receiving a dose of powder, and is movable between a first position in which said dose receiving means (47) communicate with said reservoir (20) and a second position in which said dose receiving means (47) communicate with an air passage (45) associated with said nozzle (61).

7. A device according to Claim 6 wherein said metering means comprise means (27) to create an air flow to fluidize powder in said reservoir and to deliver a metered dose thereof into said dose receiving means (47).

8. A device according to Claim 7 wherein said metering means include means (27) to increase the pressure of air in said reservoir (20) and to allow for the passage of pressurized air to vent to ambient atmosphere after passing through said dose receiving means (47) thereby loading a powder dose in said dose receiving means.

9. A device according to Claim 8 wherein means (27) are provided to increase the pressure of air in said reservoir (20) by compressing the volume of air in the reservoir.

10. A device according to Claim 9 wherein a bellows (27) is provided for compressing the volume of air in the reservoir (20).

11. A device according to Claim 6 wherein said element is a slide plate (46) with a dose receiving cavity (47) therein.

12. A device according to Claim 6 wherein said dispensing means comprise means (50,51,80) to move said element (46) from said first position to said second position.

13. A device according to Claim 12, wherein said dispensing means comprise means (51) to bias said element (46) to said second position, and means (50,81) to temporarily

maintain said element (46) in said first position against said biasing means (51), said biasing means (51) being released by said actuating means (31,72,74) after actuation of said metering means (27,37,47).

14. A device according to Claim 1 wherein said actuating means comprise cam means (72) associated with said cover (13), and control means (31) acting thereon wherein, in one position of the cam means (72), the control means (31) restrain both the metering and dispensing means (27,37,47;50,51,80), and in a second position of the cam means (72), the control means (31) are actuated to release successively said metering means (27,37,47) and then said dispensing means (50,51,80)

15. A device according to Claim 1, wherein said actuating means (31,72,74) are adapted to reset said metering and dispensing means (27,37,47;50,51,80) on closing of said cover (13).

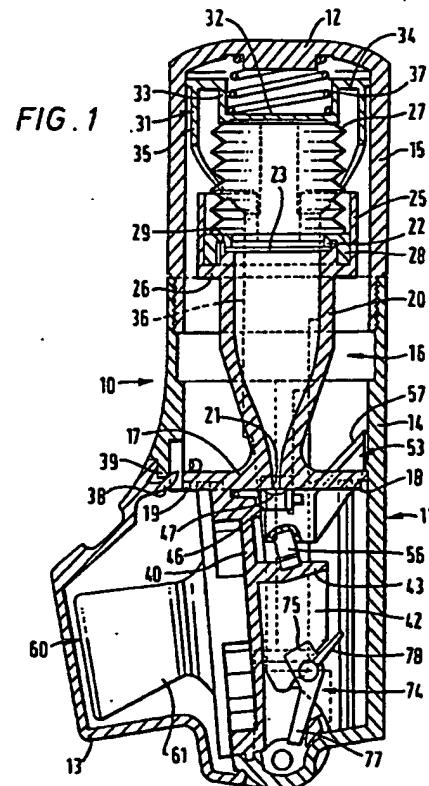

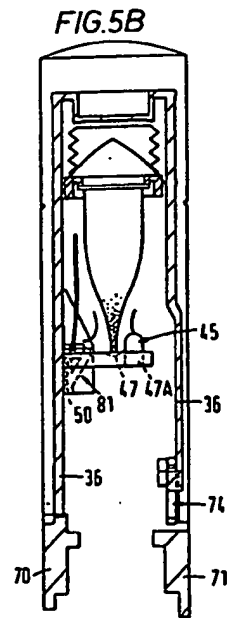
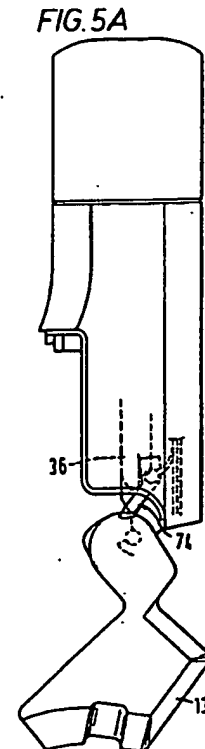
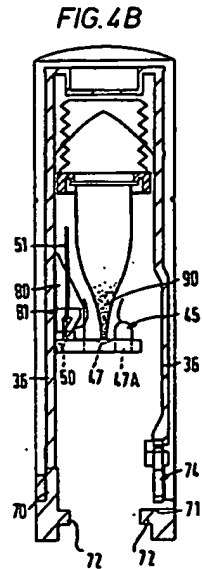
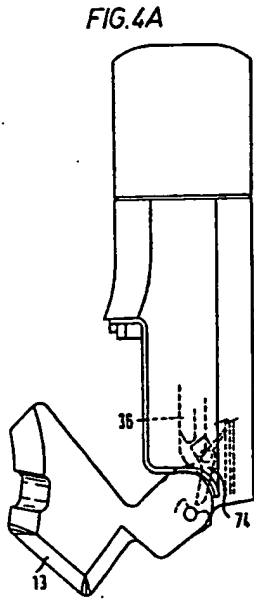
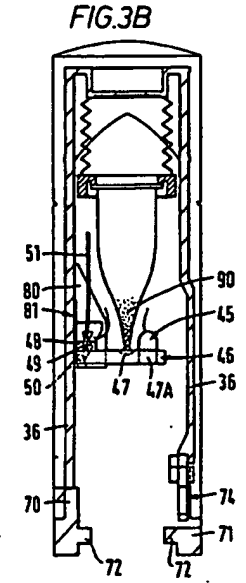
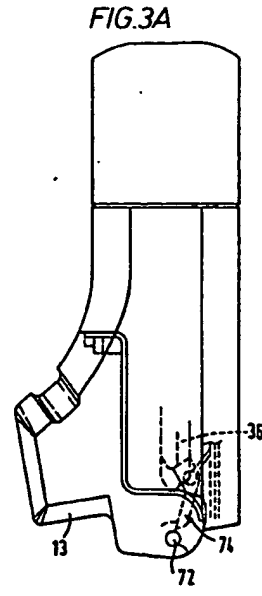
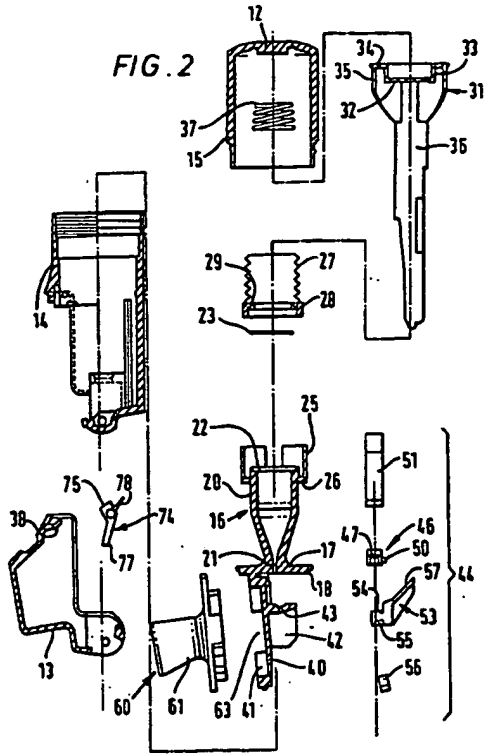

FIG.6A

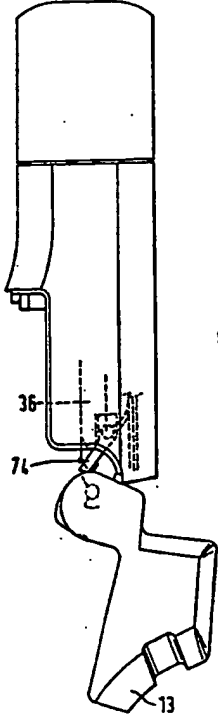

FIG.6B

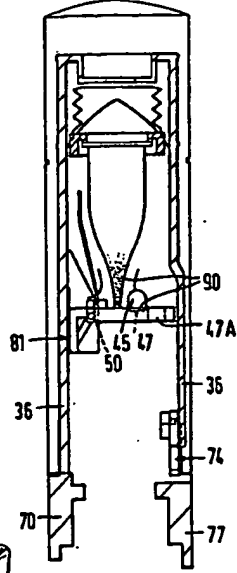

FIG.7A

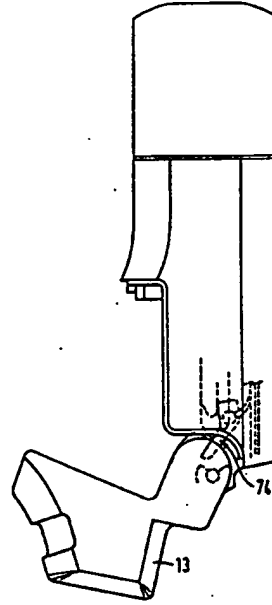

FIG.7B

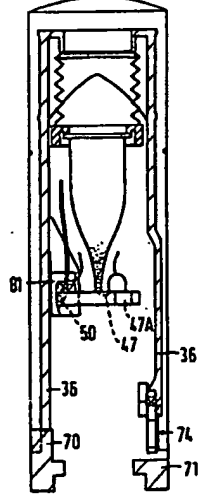

FIG.8A

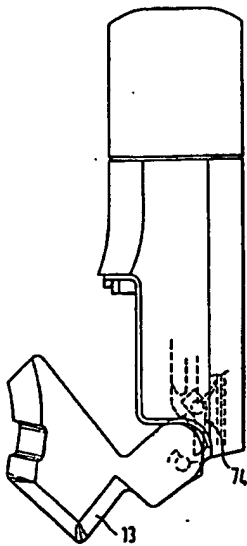
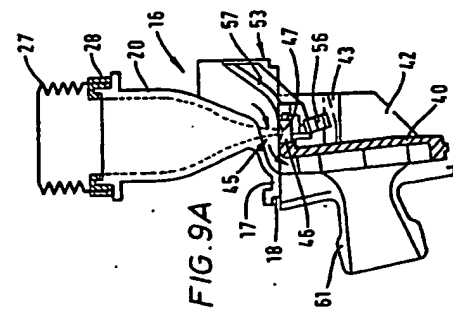
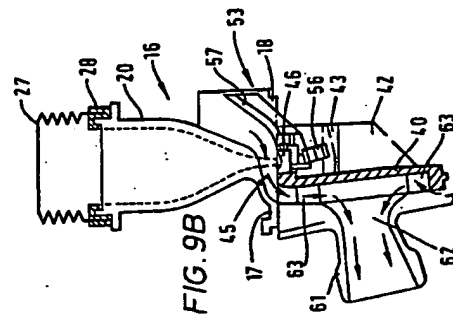
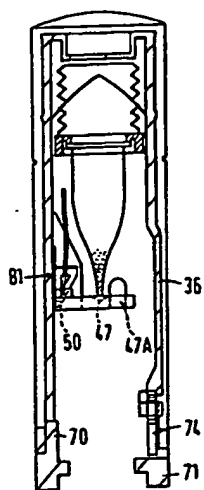

FIG.8B



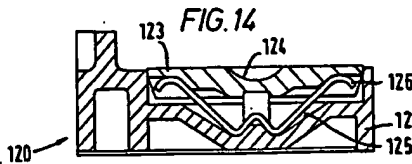
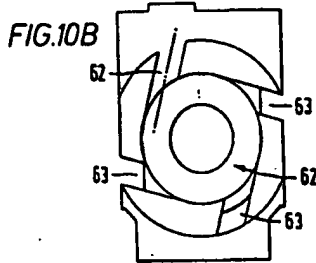
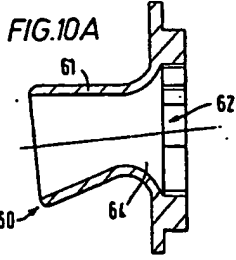

FIG. 11A

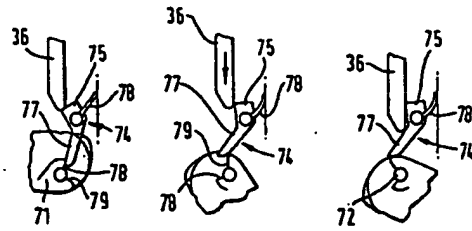

FIG. 11B

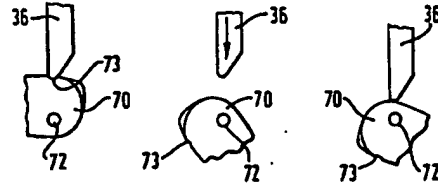

FIG. 12

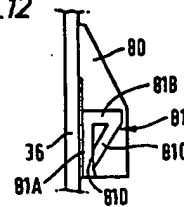

FIG. 13A

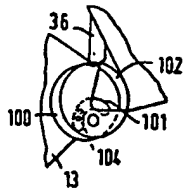

FIG. 13B

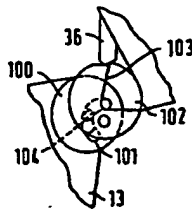

FIG. 13C

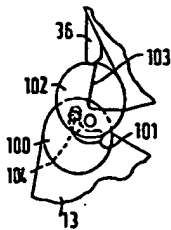
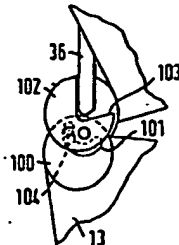

FIG. 13D



INTERNATIONAL SEARCH REPORT

International Application No. PCT/GB 93/01893

|   |  |  |
|---|--|--|
| CLASSIFICATION OF SUBJECT MATTER<br>IPC 5 A61M15/00   |  |  |
| According to International Patent Classification (IPC) or to both national classification and IPC   |  |  |
| B. FIELD OF SEARCHING   |  |  |
| Examiner's Classification searched (Classification system followed by classification symbol)  |  |  |
| IPC 5 A61M  |  |  |
| Classifications searched other than examiner's classification to be cited in this report are indicated in the table attached  |  |  |
| Abstracts also have been searched during the international search (name of this base unit, where practical, search system used)   |  |  |
| C. DOCUMENTS CONSIDERED TO BE RELEVANT  |  |  |
| Category*   | Classes of documents, with indication, where appropriate, of the relevant passages                             | Abstract to class No.  |
| X, P  | WO, A, 93 03782 (DEL BOW) 4 March 1993   | 1-6, 12, 15  |
| Y   | see page 19, line 19 - page 20, line 29; figures 10-13   | 7-9, 11  |
| Y   | WO, A, 92 10229 (MORTON HEALTHCARE LTD) 25 June 1992<br>cited in the application<br>see abstract; figures 1, 2 | 7-9  |
| Y   | US, A, 2 587 215 (PRIESTLY) 26 February 1952<br>cited in the application<br>see figures                        | 11   |
| A   | FR, A, 2 238 505 (BESPAK INDUSTRIES LTD) 21 February 1975  | 10   |
| <input type="checkbox"/> Further documents are listed in the continuation of this C. <input checked="" type="checkbox"/> Patent family members are listed in annex.   |  |  |
| * Special categories of cited documents:<br>"A" documents defining the general state of the art which is not considered to be of particular relevance<br>"X" prior documents not pertinent to or not cited in the international search report<br>"Y" documents which may draw attention to a priority document or which it may be desirable to cite in the application<br>"Z" documents relating to an oral disclosure, use, exhibition or other matter<br>"P" documents published prior to the international search which have been cited in the priority document<br>"N" documents published after the international search which are not cited in the international search report<br>"T" documents of particular relevance, the abstract translation thereof is considered to be of particular interest to the applicant<br>"F" documents of particular relevance, the abstract translation thereof is considered to be of particular interest to the applicant<br>"D" documents of particular relevance, the abstract translation thereof is considered to be of particular interest to the applicant<br>"E" documents of particular relevance, the abstract translation thereof is considered to be of particular interest to the applicant<br>"G" documents of particular relevance, the abstract translation thereof is considered to be of particular interest to the applicant<br>"H" documents of particular relevance, the abstract translation thereof is considered to be of particular interest to the applicant<br>"I" documents of particular relevance, the abstract translation thereof is considered to be of particular interest to the applicant<br>"J" documents of particular relevance, the abstract translation thereof is considered to be of particular interest to the applicant<br>"K" documents of particular relevance, the abstract translation thereof is considered to be of particular interest to the applicant<br>"L" documents of particular relevance, the abstract translation thereof is considered to be of particular interest to the applicant<br>"M" documents of particular relevance, the abstract translation thereof is considered to be of particular interest to the applicant<br>"O" documents of particular relevance, the abstract translation thereof is considered to be of particular interest to the applicant<br>"P" documents of particular relevance, the abstract translation thereof is considered to be of particular interest to the applicant<br>"Q" documents of particular relevance, the abstract translation thereof is considered to be of particular interest to the applicant<br>"R" documents of particular relevance, the abstract translation thereof is considered to be of particular interest to the applicant<br>"S" documents of particular relevance, the abstract translation thereof is considered to be of particular interest to the applicant<br>"T" documents of particular relevance, the abstract translation thereof is considered to be of particular interest to the applicant<br>"U" documents of particular relevance, the abstract translation thereof is considered to be of particular interest to the applicant<br>"V" documents of particular relevance, the abstract translation thereof is considered to be of particular interest to the applicant<br>"W" documents of particular relevance, the abstract translation thereof is considered to be of particular interest to the applicant<br>"X" documents of particular relevance, the abstract translation thereof is considered to be of particular interest to the applicant<br>"Y" documents of particular relevance, the abstract translation thereof is considered to be of particular interest to the applicant<br>"Z" documents of particular relevance, the abstract translation thereof is considered to be of particular interest to the applicant |  |  |
| Date of the international search report<br>27 December 1993   |  | Date of mailing of the international search report<br>07.01.94 |
| Name and mailing address of the Applicant<br>Parsippany Patent Office, P.O. Box 203, Parsippany, NJ, U.S.A.<br>Tel. 1-201-261-2000, Telex 203 200 200<br>Fax 1-201-261-2000   |  | Author's address<br>Villeneuve, J-M                            |



| Patent documents cited in search report | Publication date | Patent Class. (IPC Class.) | Publication date |
|---|------------------|----------------------------|------------------|
| WO-A-9303782                            | 04-03-93         | AU-A- 2421192              | 16-03-93         |
|   |                  | CA-A- 2091359              | 16-02-93         |
|   |                  | EP-A- 0553326              | 04-08-93         |
| WO-A-9210229                            | 25-06-92         | AU-A- 8932691              | 08-07-92         |
|   |                  | CA-A- 2091366              | 16-06-92         |
|   |                  | CH-A- 1062297              | 01-07-92         |
|   |                  | EP-A- 0561838              | 29-09-93         |
| US-A-2587215                            |                  | NONE                       |                  |
| FR-A-2238505                            | 21-02-75         | GB-A- 1479283              | 13-07-77         |
|   |                  | AT-B- 343819               | 26-06-78         |
|   |                  | AU-A- 7132974              | 22-01-76         |
|   |                  | BE-A- 817951               | 18-11-74         |
|   |                  | CA-A- 1027005              | 28-02-78         |
|   |                  | CH-A- 573254               | 15-03-76         |
|   |                  | DE-A- 2435186              | 06-02-75         |
|   |                  | JP-A- 50071195             | 12-05-75         |
|   |                  | KL-A- 7409739              | 27-01-75         |
|   |                  | SE-A- 7409485              | 24-01-75         |
|   |                  | US-A- 3921637              | 25-11-75         |

Form PCT/GB 93 patent family member July 1993